

Article number: 209076181

Description: E+G Ball point screw
GN 605-M6-16-VNR

Measures

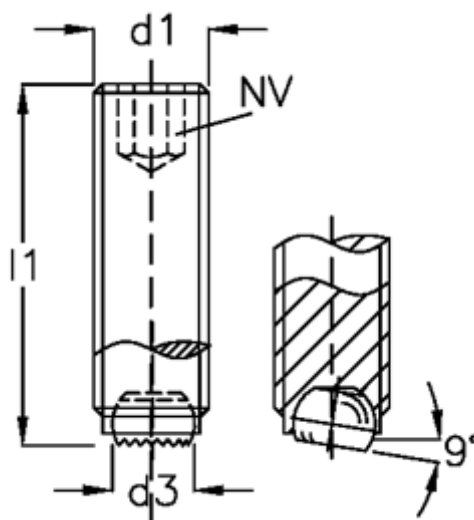

d1	= M6
d2	= 4.0
d3	= 3.2
Internal hexagon	= 3
l1	= 16